

Some Reactions of Cyclotetrathiazium Chloride (S_4N_3Cl) † Vapour at Hot Metal (Iron, Titanium, or Silver) Surfaces. An Alternative Route from S_4N_3Cl and Silver to Disulphur Dinitride and hence Poly(sulphur nitride)

By Arthur J. Banister * and Zdenek V. Hauptman, Department of Chemistry, University of Durham, Science Laboratories, South Road, Durham DH1 3LE

Cyclotetrathiazium chloride (thiotriazolyl chloride, S_4N_3Cl) vaporized at *ca.* 130 °C reacts with (i) iron, (ii) titanium, and (iii) silver (at *ca.* 300 °C) to give respectively (i) S_3N_2Cl , S_4N_4 , and $(NSCl)_3$, (ii) sulphur, nitrogen, and $TiCl_4$, and (iii) S_2N_2 , Ag_2S , and $AgCl$, as the major products. The isolation of S_2N_2 from the silver reaction and its polymerization to poly(sulphur nitride) are also described.

It has recently been shown¹ that cyclotetrathiazium chloride (S_4N_3Cl) suspended in a hot non-aqueous solvent (*e.g.* nitromethane) reacts with iron, aluminium, or titanium to yield tetrasulphur tetranitride as a major product. Depending upon the reaction conditions, the metal functions as a reactant and/or as a catalyst.

We have therefore studied analogous reactions between vaporized S_4N_3Cl and selected metals which are likely to combine with chlorine at elevated temperatures and yield S_xN_y species. This type of vapour-phase reaction of $SNCl$ compounds has not hitherto been studied.

EXPERIMENTAL

Reagents.—Cyclotetrathiazium chloride (S_4N_3Cl) was prepared² from $S_3N_2Cl_2$ and recrystallized from thionyl chloride. The thionyl chloride was purified by two-fold distillation from triphenyl phosphite.³ The fine yellow crystals were dissolved (*ca.* 1 g in 10 cm³) in refluxing thionyl chloride and cooled slowly to room temperature, under dry nitrogen. Care was taken that the recrystallization temperature did not fall much below 20 °C since, when cooled in a refrigerator (*ca.* -5 °C) or evaporated under reduced pressure, the solution usually darkened and the precipitated yellow crystals turned dark green. Such contaminated product contained four extra i.r. absorptions at 965, 945, 710, and 590 cm⁻¹ (probably due to S_3N_2Cl).⁴

Iron wire (B.D.H., diameter 0.2 mm) was purified (reduction of surface oxides) by heating at *ca.* 600 °C in a stream of a H_2 -HCl gas mixture (10 : 1 at 0.5 cm s⁻¹ linear flow rate) then coiled and arranged into a plug tightly fitting into the pyrolysis tube (see Figure; position i).

Iron sponge (JMC, 'Specpure') was lightly sintered (at 380 °C) to convenient lumps in pure hydrogen.

Crushed titanium sponge (B.D.H.) was sieved and a fraction ranging from 0.7 to 1.4 mm grain size was used to ensure a uniform packing of the reaction zone.

Silver wool (B.D.H., 99.99%, 50 µm diameter) was coiled and formed into plugs. The plugs were degreased with hexane in a Soxhlet extractor, washed in concentrated ammonia, and dried *in vacuo*.

Apparatus and Procedure.—The vacuum unit equipped with an Edwards EO2 150 l s⁻¹ oil diffusion pump afforded, after 5–6 h, an ultimate vacuum of 5×10^{-7} Torr.‡ The

all-glass pyrolysis apparatus, see Figure, consisted of a train of two U-tubes (g and h) and the pyrolysis tube (i). A jointless system with seal-off sections was chosen since it allowed a large proportion of the apparatus to be flamed out *in vacuo*, and thus to achieve a thorough degassing. It also facilitated the transfer, isolation, and storage of the volatile moisture sensitive products.

The following basic procedure was common to all S_4N_3Cl -metal reactions. Weighed quantities of the reactants were placed in the pyrolysis tube as shown in the Figure. The iron and titanium sponge were supported by two tufts of

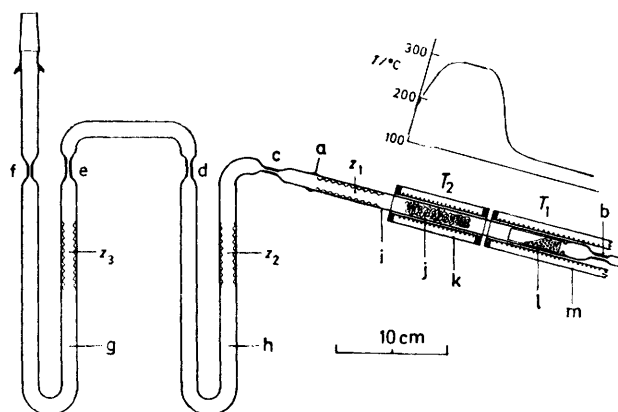

Pyrolysis apparatus. The inset diagram shows the temperature distribution along the axis of the pyrolysis tube

Saffil[®] zirconia fibre (product of I.C.I., Mond Division) chosen because of its resilience, purity, and inertness. The silver wool and iron wire were held in position by friction. The pyrolysis tube was welded to the rest of the apparatus (at a) during which operation the tube was being back-flushed with dry nitrogen through constriction b so as to protect the S_4N_3Cl charge (l) from the moisture arising from the torch flame. The constriction b was then sealed off and the pressure was gradually reduced. On reaching *ca.* 10^{-6} Torr, the pyrolysis tube section containing the metal (j) was heated up to 300 ± 2 °C and maintained at this temperature by means of a transparent Pyrex furnace (k). The three main zones (z_1 , z_2 , and z_3) of condensation of volatiles were kept at 20, 0, and -196 °C respectively. The temperature (T_1) of S_4N_3Cl was manually increased in steps from 20 to 130 °C using a transparent Pyrex furnace (m), typically, over a period of 6 h in order to allow enough time for degassing. When all the S_4N_3Cl had volatilised (10–18 h) the constrictions c, d, and f were sealed off in this order.

† 1,2,4,6-Tetrathia-3,5,7-triazapenium chloride.

‡ Throughout this paper: 1 Torr = (101 325/760) Pa; 1 atm = 101 325 Pa

The section between c and e was used for subsequent separation of volatiles (*e.g.* S_4N_2) from the condensates in zone z_3 . The isolation and handling of the condensates from the sealed sections of the apparatus was carried out in a glove box under nitrogen.

RESULTS AND DISCUSSION

Reaction between S_4N_3Cl and Fe(wire).—This system was composed of 0.750 g (3.64 mmol) S_4N_3Cl and 1.43 g (25.70 mmol) iron wire, calculated free surface area of 36 cm^2 . The total duration of the experiment was 11 h. The first observable deposit (beginning at $T_1 = 75^\circ C$) was a brown ring at zone z_3 . At $T_1 = 115^\circ C$ a thin amber coloured layer appeared in z_1 and z_2 . On reaching $T_1 = 130^\circ C$ ($p = 6 \times 10^{-5}$ Torr) a dark blue layer started to grow in zone z_1 . At the same time the amount of the deposit in z_3 increased and acquired a colour gradation from dark brown (at the liquid-nitrogen level) to orange, yellow, and white (deeper down the Dewar vessel). On complete vaporization of S_4N_3Cl there was a thick black deposit in zone z_1 (discussed later). The pyrolysis tube was broken into sections, the weight of the deposit and the weight change of the iron wire (ΔM) were determined; black deposit: 0.187 g, $\Delta M = 0.0044$ g (0.31%). The deposit was characterized using i.r., X-ray powder photographs, and chemical analyses (Found: Cl, 14.5; N, 18.05; S, 68.15%. S_3N_2Cl requires Cl, 22.25; N, 17.55; S, 60.2%).

The deposit was relatively moisture insensitive, *viz.* no visible changes after several hours exposure to air. The i.r. spectrum (KBr and KCl discs) corresponded to that of S_3N_2Cl (ref. 4) with minor absorptions (925 and 550 cm^{-1}) due to S_4N_4 . The X-ray powder photographs taken by the Guinier-DeWolff fully focusing camera (Nonius, Delft) also confirmed, by comparison with standard samples, the presence of some S_4N_4 and S_8 . No iron chlorides were detected in the condensates.

The identification of the volatile products trapped in zone z_3 was rather difficult because of their moisture sensitivity. The major component (from i.r. spectra) was $(NSCl)_3$. The other minor concomitant volatiles were probably S_2N_2 and S_4N_2 .

Discussion. In this system, the amount of iron entering the reaction was very small (the weight increase was only 0.31%) and so the iron wire (and the Fe-S clusters formed on the surface) probably acted mainly as a catalyst. The presence of iron sulphides on the surface was established by a positive H_2S reaction (on reduction with H_2).

The incomplete reaction with iron (*cf.* the following reaction) was clearly due to slow solid-state diffusion.

Infrared spectra of the black glassy deposit from zone z_1 showed prominent bands due to S_3N_2Cl . X-Ray powder diagrams indicated that S_4N_4 and S_8 were the only other minor constituents. This was supported by chemical analysis on the homogenized deposit, which corresponded to S_8 , S_4N_4 , and S_3N_2Cl in the ratio 0.46 : 1.00 : 8.47.

The main reaction can therefore be summarized in

equation (1). Formally, it appears as if the $S_4N_3^+$ underwent a ring contraction. To establish the role of

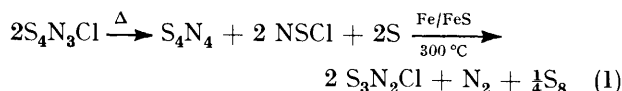

the sulphided iron in this unusual process would require further studies, *e.g.* using sintered Fe_xS_y samples with a large surface area.

The pressure in the pyrolysis apparatus as a function of time (monitored by a Penning gauge) showed an increase from 2×10^{-6} to 5×10^{-4} Torr when the reaction started. It fluctuated around this value throughout the entire reaction and dropped back to 10^{-6} Torr when all S_4N_3Cl had decomposed. This indicated that the process was accompanied by liberation of nitrogen in agreement with equation (1).

The S_4N_4 (in zone z_1) and $(NSCl)_3$ (in zone z_3) were probably products which did not succeed in reacting at the metal surface. The formation of S_3N_2Cl by the pyrolysis of S_4N_3Cl has not been reported previously although the opposite reaction has been observed,⁵ *viz.* the formation of S_4N_3Cl by thermal decomposition of S_3N_2Cl at temperatures 130–150 $^\circ C$.

Reaction between S_4N_3Cl and Fe (sponge).—This system was composed of 0.330 g (1.60 mmol) S_4N_3Cl and 2.62 g (46.84 mmol) iron sponge. The specific free surface area of the iron sponge was not known exactly but it was estimated to be larger by a factor of 10^3 compared with the iron wire (estimate based on an electron micrograph). Not surprisingly, the course of this reaction [equation (2)] was quite different. A quantitative reaction took

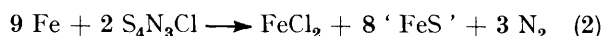

place and no volatile product passed beyond the iron-sponge zone. The weight gain of the iron sponge corresponded to 79.45 weight % of the S_4N_3Cl ; the sum of sulphur and chlorine content constituted 79.57 weight % of S_4N_3Cl .

Thus, the use of an excess of iron in a highly dispersed state resulted in both 'FeS' and $FeCl_2$ being formed simultaneously and quantitatively at a relatively low temperature (300 $^\circ C$).

Reaction between S_4N_3Cl and Ti (sponge). This system was composed of 0.577 g (2.80 mmol) S_4N_3Cl and 3.13 g (65.34 mmol) titanium sponge. Soon after the start of the reaction a white to pale yellow crystalline deposit appeared in zones z_1 , z_2 , and z_3 . The deposits in z_1 and z_2 were identified as elemental sulphur (analysis, mass spectrum, no absorptions in i.r. range). The deposit in z_3 was isolated by sealing off the U-tube (g).

During warming up to room temperature the deposit melted sharply at $-25^\circ C$ to a colourless liquid. It was later identified as $TiCl_4$ and its mass (0.107 g, 0.56 mmol), found by weighing and confirmed by chemical analysis [Found: Ti, 0.0269 g (0.61 mmol)], accounted for *ca.* 83% of the chlorine present in the initial amount of S_4N_3Cl . A repeat experiment was very reproducible and

the amount of TiCl_4 isolated from z_3 corresponded to 87% of the initial amount of chlorine. The remainder was probably contained in the titanium sponge as TiCl_3 or TiCl_2 .

Discussion. The reaction with the titanium sponge resulted in complete breakdown of $\text{S}_4\text{N}_3\text{Cl}$ [equation (3)].

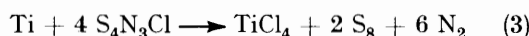

A slight net increase in weight (0.09 g) of the sponge after the reaction was probably due to residual chlorine bonded as lower titanium chlorides. Despite the large excess of titanium, TiCl_4 was predominantly formed (not TiCl_3 or TiCl_2). This is understandable because of the tendency of the lower titanium halides to disproportionate, *e.g.*⁶ equation (4).



Reaction between $\text{S}_4\text{N}_3\text{Cl}$ and Ag (wool).—This system was composed of 0.460 g (2.24 mmol) $\text{S}_4\text{N}_3\text{Cl}$ and 1.373 g (12.73 mmol) silver wool. The reaction progressed in three distinct stages. (i) For *ca.* 2 h after the temperature of the $\text{S}_4\text{N}_3\text{Cl}$ steadied at 130 °C the reaction remained confined to the silver zone (formation of Ag_2S and AgCl). (ii) In the second stage two simultaneous processes were observed: the formation of a blue transparent layer in z_1 and the formation of white S_2N_2 deposits in z_2 and z_3 . After *ca.* 3 h when more than half of the initial $\text{S}_4\text{N}_3\text{Cl}$ charge was spent the appearance of a brown substance in z_3 introduced the third stage of the reaction. This stage was characterized by continuing formation of S_2N_2 accompanied by simultaneous production of intensively coloured (orange to brown) by-products which contaminated the disulphur dinitride. Towards the end of the reaction an orange-yellow ring formed at the top of zone z_3 [later identified as $(\text{NSCl})_3$]. A second experiment reproduced the three-stage course of the reaction. In a third experiment partially sulphided silver wool was used in place of the pure wool. Here, the first stage was absent and an immediate formation of the blue deposit [characteristic of stage (ii)] occurred as soon as the temperature of the $\text{S}_4\text{N}_3\text{Cl}$ charge reached *ca.* 100 °C. The disulphur dinitride (yield *ca.* 55%), along with some other volatile constituents, was collected in a U-tube (g), cooled to -196°C , and sealed off (at d and f). The S_2N_2 crystals grew at room temperature and were allowed to polymerize over a period of six weeks. After that time all deposits, irrespective of their original colour, turned dark blue. The $(\text{SN})_x$ crystals which grew partly on clean glass surfaces and partly on the dark blue felt-like layers exhibited a brassy yellow colour and a high metallic lustre. They ranged from submillimetre to millimetre sizes, a large proportion had well developed facets and belonged decidedly to the 'less fibrous' class.⁷

One of the well developed crystals was analysed by electron probe microanalysis (e.p.m.a.) for sulphur and chlorine. The crystal was embedded in epoxy resin (Araldite) so that its natural $(10\bar{2})$ plane (*ca.* 1.2×1.2 mm) was exposed to the electron beam. Ten 10-s counts were recorded from each of the three analysed spots. A

defocused beam (*ca.* 25 μm at the specimen surface) was used since a fully focused beam of the Geoscan instrument (*ca.* 3 μm) caused an instant evaporation of the polymer and an instability in the specimen current. With the defocused beam consistent readings were obtained. The counts were corrected using the program developed by Duncumb and Jones.⁸ Another crystal of $(\text{SN})_x$, prepared by the usual route from S_4N_4 , was analysed simultaneously for comparison. The results obtained are shown in the Table.

Electron probe microanalysis of $(\text{SN})_x$ crystals

Spot no.	From $\text{S}_4\text{N}_3\text{Cl}$		From S_4N_4	
	Sulphur (wt. %)	Chlorine (wt. %)	Sulphur (wt. %)	Chlorine (wt. %)
1	69.65	0.03	69.36	0.03
2	69.49	0.07	69.34	0.00
3	69.47	0.00	69.32	0.00
	av. 69.54	0.05	69.34	0.01
	theory 69.59			

The silver wool was weighed before and after the reaction (the increase in weight being due to sulphur and chlorine). An analytical determination of the two elements was carried out as follows. The reacted silver-wool plug was transferred into a small tubular quartz furnace and pure dry hydrogen was passed over while the temperature was gradually raised to 850 °C.* The outlet from the furnace was connected to a specially designed absorber filled with $\text{Na}[\text{OH}]$ solution (20 cm^3 , 0.5 mol dm^{-3}) which was kept in circulation by a gas-lift pump to ensure complete absorption of the hydrogen chloride from the H_2 - HCl - H_2S mixture. On neutralization with sulphuric acid the sulphide ion was precipitated as CdS . The chloride in the filtrate was determined by potentiometric titration with a Ag-AgCl electrode. The amounts of chlorine found in the silver wool from three separate $(\text{SN})_x$ syntheses were 86, 89, and 78% of the total content of Cl present in the initial $\text{S}_4\text{N}_3\text{Cl}$ charge. The last figure, 78%, relates to an experiment where partially sulphided silver-wool was used instead of the pure metal.

The blue deposits from zone z_1 (typically 50 mg in weight) were scraped out for X-ray powder analyses. Using the fully focusing camera mentioned previously with $\text{Fe-K}_{\alpha 1}$ monochromated light only diffraction lines of $(\text{SN})_x$ and S_4N_4 were detected.

Discussion. It is well known that $\text{S}_4\text{N}_3\text{Cl}$ does not sublime *in vacuo* but thermally decomposes (at a significant rate at 120 °C) into sulphur-nitrogen and sulphur-nitrogen-chlorine species. In order to rationalize the mechanism of the processes involved in our experiments it was important to establish the identity of the species which arrived at the hot metal zone from the thermally decomposing $\text{S}_4\text{N}_3\text{Cl}$. In a typical run (130 °C, 10^{-5} – 10^{-4} Torr) we may assume that bimolecular reactions in the gas phase do not occur, and therefore, the species leaving the decomposition zone reach the reaction zone unchanged.

A conventional mass spectrometric analysis of $\text{S}_4\text{N}_3\text{Cl}$

* This was also a convenient way of regenerating the silver.

(70 eV ionizing potential, probe temperature range 80–150 °C) showed the presence of NSCl⁺ and a family of S_xN_y fragments which may originate from S₄N₄ molecules. No traces of S₄N₃Cl⁺ (*m/e* 205) were detected. Peake and Downs⁹ used a controlled pyrolysis of cyclotetrathiazium halides (Cl, Br, and I) to generate corresponding thiazyl halides for their matrix-isolation studies. The monomeric molecules NSCl and NSBr were the only halogen-containing species isolated in the matrix. No formation of NSI was detected. On the basis of their results they formulated the pyrolysis reaction as equation (5). This mechanism seems to be supported by our

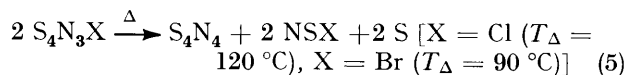

experiments with the S₄N₃Cl–Ag reaction couple; here, the S₄N₄ molecule formed from S₄N₃Cl vapour undergoes the known splitting into S₂N₂ while NSCl is dehalogenated by Ag and/or Ag₂S, thus yielding equations (6) and (7).

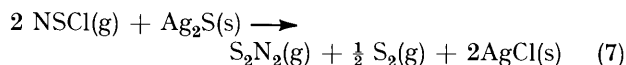
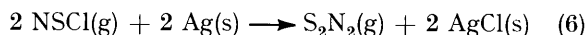

The reaction of S₄N₃Cl (vapour) with Ag₂S (partially sulphided silver wool) leads to a slightly lower degree of dehalogenation (78%) than in the reactions with initially pure silver wool (86 and 89%). The cause of a lower degree of dehalogenation in the former reaction may be of kinetic rather than thermodynamic origin. In view of the lack of thermochemical data for reaction (7) we have made an estimate of its feasibility based on reactions (8)–(10). Literature thermochemical data¹⁰ for the

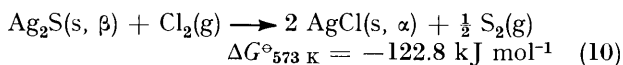
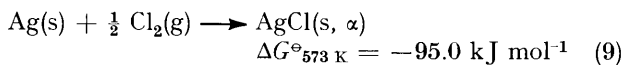
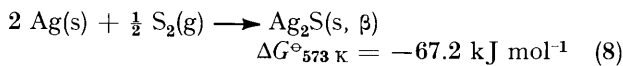

reactions (8) and (9) have been used to obtain the value of the standard free enthalpy change for reaction (10). Since Ag₂S and AgCl do not form solid solutions¹¹ one may consider their chemical activities as unity during the course of reaction (10), and hence the equilibrium constant $K_p(T) = [a_{\text{AgCl}}^2 \times (p_{\text{S}_2})^{1/2}] / [a_{\text{Ag}_2\text{S}} \times p_{\text{Cl}_2}]$ reduces to $K_p(T) = (p_{\text{S}_2})^{1/2} / p_{\text{Cl}_2}$; at 573 K its value equals $1.5 \times 10^{11} \text{ atm}^{-1}$. The equilibrium at 300 °C is therefore strongly in favour of AgCl. To conclude whether the same applies to reaction (7) (*i.e.* for NSCl instead of Cl₂), we compared the available data¹² on bond energies of Cl–Cl (in Cl₂) and S–Cl (in S₂Cl₂). Their proximity, 242.7 and 255.2 kJ mol⁻¹ respectively, indicates that reaction (7) is thermodynamically possible.

The kinetics of AgCl formation will depend largely on the solid-state diffusion. From recent measurements¹³ of the diffusion of sulphur into solid silver an extrapolated

value for the diffusion coefficient at 300 °C is $D = 2.18 \times 10^{-13} \text{ cm}^2 \text{ s}^{-1}$. This further leads to an estimate that sulphur would penetrate approximately 1.8 μm deep into the (25 μm radius) silver wire in 10 h. Opposing this estimate is the observed rate of the sulphidation of silver wool when exposed to the S₄N₄ vapour. A complete conversion occurs in *ca.* 10 h at 300 °C (*i.e.* a penetration depth of 25 μm). The explanation must therefore be sought in another mechanism; probably the high mobility of silver atoms through the Ag₂S (and AgCl) lattice is responsible for the high rate of sulphidation (chlorination) of silver. Recently much attention has been paid to the diffusion of silver atoms in silver chalcogenides.^{14–16} According to measurements by Ohachi and Taniguchi¹⁶ the diffusion coefficient for the Ag⁺–e⁻ pair in the Ag₂S lattice at 280 °C is as high as $8 \times 10^{-2} \text{ cm}^2 \text{ s}^{-1}$, thus accounting for our observations.

At present we do not know how the concentration ratio Ag₂S: AgCl varies during the reaction in the surface layer and to what extent the presence of AgCl affects the catalytic splitting of S₄N₄ to S₂N₂. It is likely that the onset of the third stage (appearance of brown deposits) in the S₄N₃Cl–Ag reaction is associated with some critical degree of surface saturation by AgCl.

We did not attempt to isolate the brown deposits. They do not seem to polymerize as rapidly as the brown monomer SN• reported by Love *et al.*¹⁷ In our experiment the brown deposits became intimately mixed with the underlying S₂N₂ and the whole mixed mass turned dark blue in the course of polymerization. Interestingly, these brown coloured deposits and the presence of a small amount (*ca.* 50 mg) of (NSCl)₃ in the U-tube did not seem to impair the quality of the chlorine-doped (SN)_x crystals, as assessed by visual appearance under a microscope (magnification 20–30×).

The vapour pressure of the monomeric NSCl in equilibrium with its oligomer (NSCl)₃ at 20 °C was *ca.* 11.0 Torr¹⁸ and it seemed likely that some chlorine would be incorporated into the (SN)_x crystals. Unfortunately, no quantitative vapour-pressure data are available for the system S₂N₂(s)–S₂N₂(g), but from a qualitative comparison of the relative sublimation rates of S₂N₂ and (NSCl)₃ under identical conditions, it appears that S₂N₂ is the more volatile. However, the sublimation rate of the initially ‘pure’ source S₂N₂ diminishes considerably as its polymerization to (SN)_x advances. Consequently, during the formation of S₂N₂ crystals, the falling concentration of the nutrient S₂N₂ vapour in the vicinity of the growing crystals will in time become equal to the concentration of NSCl. Nevertheless, the e.p.m.a. of the resulting (SN)_x crystals showed only a small content of chlorine (*ca.* 0.05%), and so one may conclude that the NSCl molecules impinging on the surface of the growing and polymerizing S₂N₂ crystals are not readily accommodated into the lattice.

CONCLUSIONS

Cyclotetrathiazium chloride which is easily accessible, and unlike tetrasulphur tetranitride non-

explosive, provides an alternative starting compound for the synthesis of $(\text{SN})_x$ crystals. In the vapour at *ca.* 130 °C it is reduced by silver to S_2N_2 (*ca.* 55% yield) which polymerises to $(\text{SN})_x$ in 4–6 weeks.

The presence of $(\text{NSCl})_3$ (resulting from a usually incomplete dechlorination of the $\text{S}_4\text{N}_3\text{Cl}$ vapour by silver) which is collected together with S_2N_2 in a cooled trap does not inhibit the growth of good quality $(\text{SN})_x$ crystals, although the gaseous thiazyl chloride (present due to the trimer–monomer equilibrium) is most likely responsible for the chlorine doping (order of 10^{-2} weight %) of the $(\text{SN})_x$ crystals formed.

$\text{S}_4\text{N}_3\text{Cl}$ vapour reacts with sulphided iron wire and undergoes an unusual ring contraction to $\text{S}_3\text{N}_2\text{Cl}$.

We thank Mr. R. Coult for chemical analyses, Dr. M. Jones and Mr. D. L. Nevins for mass spectra, and Mr. W. Davidson from the School of Physics, University of Newcastle upon Tyne, for the e.p.m.a. analyses. We also express our thanks to the S.R.C. for a Research Grant.

[9/1115 Received, 16th July, 1979]

REFERENCES

- ¹ A. J. Banister, A. G. Fielder, R. G. Hey, and N. R. M. Smith, *J.C.S. Dalton*, in the press; A. J. Banister, A. G. Fielder, Z. V. Hauptman, R. G. Hey, and N. R. M. Smith, 'Producing Sulphur-Nitrogen Groups,' B.P. Appl. 7,924,580/1979.
- ² W. L. Jolly and K. D. Maguire, *Inorg. Synth.*, 1967, **9**, 106.
- ³ L. Friedman and W. P. Wetter, *J. Chem. Soc. (A)*, 1967, 36.
- ⁴ G. Wolmershäuser, C. R. Brulet, and G. B. Street, *Inorg. Chem.*, 1978, **17**, 3586.
- ⁵ W. Jolly, K. D. Maguire, and D. Rabinovich, *Inorg. Chem.*, 1963, **2**, 1304.
- ⁶ Z. Hauptman, D. Schmidt, and S. K. Banerjee, *Coll. Czech. Chem. Comm.*, 1967, **32**, 2421.
- ⁷ G. B. Street and R. L. Green, *IBM J. Res. Develop.*, 1977, **21**, 99.
- ⁸ P. Duncumb and E. M. Jones, 'Electronprobe microanalysis: an easy to use program for correcting quantitative data,' Tube Investments, Saffron Walden, Technical Report No. 260, 1969.
- ⁹ S. C. Peake and A. J. Downs, *J.C.S. Dalton*, 1974, 859.
- ¹⁰ 'Termodinamicheskie svoistva neorganicheskikh veshchestv,' ed. A. P. Zefirov, Spravochnik, Atomizdat, Moscow, 1965, pp. 201, 203.
- ¹¹ M. C. Bell and S. N. Flengas, *J. Electrochem. Soc.*, 1964, **111**, 569.
- ¹² M. L. Huggins, *J. Amer. Chem. Soc.*, 1953, **75**, 4123.
- ¹³ K. Fueki, K. Ota, and K. Kshio, *Bull. Chem. Soc. Japan*, 1978, **51**, 3067.
- ¹⁴ Gmelins Handbuch der anorganischen Chemie, 8th edn., Silber, Verlag Chemie, GMBH-Weinheim/Bergstrasse, 1973, Teil B3, Syst, Nr. 61, pp. 2, 9, and 24.
- ¹⁵ I. Okabe and M. Nakagawa, *J. Cryst. Growth*, 1979, **46**, 504.
- ¹⁶ T. Ohachi and I. Taniguchi, *Electrochim. Acta*, 1977, **22**, 747.
- ¹⁷ P. Love, G. Meyer, H. I. Kao, M. M. Labes, W. R. Junker, and C. Elbaum, *Ann. New York Acad. Sci.*, 1978, **313**, 745.
- ¹⁸ R. L. Patton, Ph.D. Thesis, University of California, Berkeley, 1969.